

----- Please read this manual carefully before installing and using the product -----

BEFORE INSTALLING

NOTICE: This manual should be left with the owner/user of this equipment.

IMPORTANT: The detector must be tested and maintained regularly following the proper authorities' requirements. The detector should be cleaned and recalibrated at least once a year.

1. Overview

The detector is positioned using a high-power infrared laser head with high-precision concentricity. The focal point is small at long distances, the light spot is the brightest and most concentrated, it is consistent, long-term stable and reliable.

The lenses of product are professionally designed to ensure good product performance and the stability of product signals even in long-distance use; at the same time, it can provide a distance of up to 160m. This product uses a 32-bit controller with very strong performance, it has rich resources and large memory; it runs at a fast frequency, responds sensitively, controls quickly, and can detect subtle changes.

The advanced intelligent algorithm ensures that the product can be used in various complex places while maintaining the original goal of the most sensitive and stable performance; it greatly simplifies the work of installers and greatly reduces the professional requirements for installers. Just turn on the laser and adjust it to the reflective board, and the rest will be completed by the powerful algorithm program.

It has a beautiful appearance and practical. It has separation between inside and outside. It has abundant connection terminals (interfaces), which makes connection flexible and convenient.

AW-D130 Series Reflective Optical Beam Smoke Detector is made up of infrared mirrors, etc. It greatly simplifies the work of installers and greatly reduces the professional requirements for installers. Just turn on the laser and adjust it to the reflective board, and the rest will be completed by the powerful algorithm program.



2. Order Information

Model No.	Name
AW-D130C	Conventional Optical Beam Smoke Detector (With 4 mirrors)
AW-D130A	Addressable Optical Beam Smoke Detector (With 4 mirrors)
AW-D130-5RF	5 mirrors included in 1 package (Only for distance exceeding 100m)

3. Product characteristics

- High-transparency telescope structure
- Easy debugging, accurate and fast alignment, intelligent and fast calibration;
- High quality, durability and highly sensitive sensor
- Automatic compensation, improves the ability to resist dust and vibration interference and reduces false alarms.
- Optical distance can reach to maximum 160m, minimum 5m
- Excellent reliability and stability
- Exquisite appearance, large detection range

- Supports both addressable and conventional applications
- Support isolation function
- Support infrared remote control operation.
- Suitable for all larger warehouses or more open protection places
- Meets all requirements of the latest EN54-12 standard

4. Technical Parameters

- Working Voltage : Loop24V or DC12-24V
- Working Current: static current ≤ 10 mA@DC24V, alarm current ≤ 15 mA@DC24V
- Laser Concentricity : $\leq 1^\circ@160$ m
- Beam Misalignment : $\pm 0.8^\circ@160$ m
- Alarm Sensitivity: High ≤ 2.6 dB; Medium ≤ 3.8 dB; Low ≤ 5.0 dB.(Default is medium)
- Relay Load Capacity: 1A@DC24V
- Optical Detection Distance: 5 -160m
- Protection area: The maximum protection area of the detector is $14*160=2240$ m², and the maximum width is 14m.
- Working Temperature: $-10^\circ\text{C}\sim 50^\circ\text{C}$, Working Humidity: 5% to 95% (non-condensing)
- Materials and Colors: ABS, white
- Size: 184.3mm*143.3 *120mm (Figure1)
- Weight: about 555 g
- Standard Number Ref: EN54-12

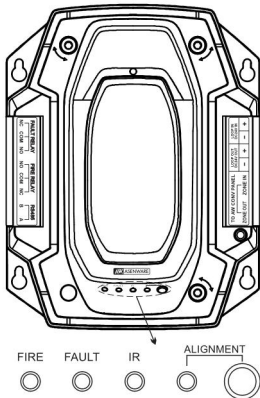

5. Operation panel description

1. FIRE indicator light - red LED, indicating fire alarm
2. FAULT indicator light - yellow LED, indicating fault indicator light
3. ALIGNMENT is a combination of a green indicator light and a touch switch, used for work indication and switching red laser, as well as calibration work.
4. IR is the infrared remote control receiving window

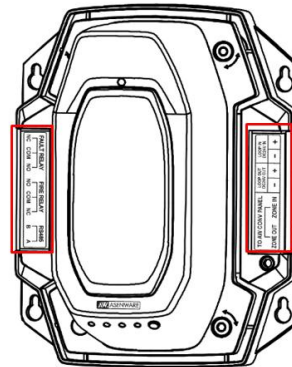

6. Terminal Board Wiring Instructions

TO AW CONV PANEL		LOOP OUT DC24V OUT		LOOP IN DC24V IN	
ZONE OUT	ZONE IN	-	+	-	+

6.1 TO ASENWARE CONV PANEL:

ZONE IN: Connect to the ZONE of the ASENWARE conventional panel Loop or output loop of the upper level device.

ZONE OUT: Connect to the ZONE of the next ASENWARE conventional device Input port.

6.2 LOOP IN / DC2 4 V IN:

Polarity addressable LOOP input or conventional DC 24 V power supply input to connect to the previous device.

6.3 LOOP OUT / DC2 4 V OUT:

Polarity addressable LOOP output or conventional DC 24 V powered loop output for connection to the next device.

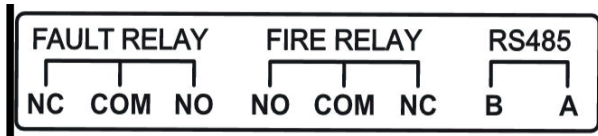

6.4 FAULT RELAY: (For AW-130C only)

Fault relay output terminals, NO/NC/COM;

6.5 FIRE RELAY: (For AW-130C only)

Fire alarm relay output terminals, NO/NC/COM.

6.6 RS 485 : (For AW-130C only)

External communication interfaces A and B are used in the same direction.

7. Overall dimensions and installation hole dimensions

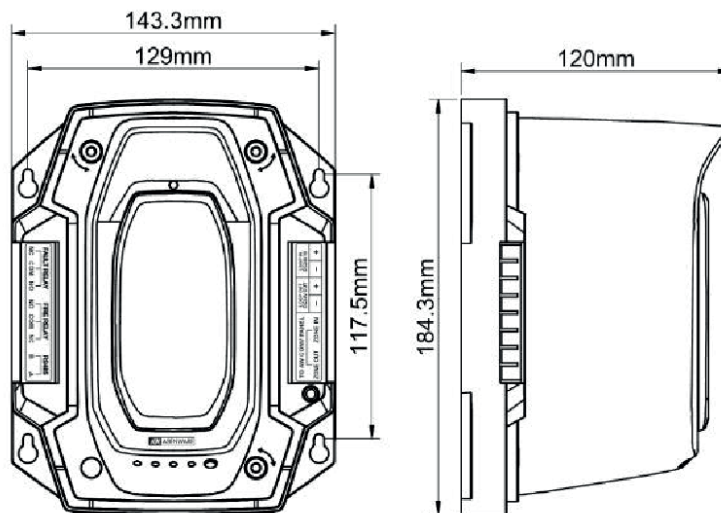

8. Product installation requirements:

8.1 Detector installation requirements

1. Under flat spare area. If the ceiling height is less than 8 meters, the beam detector should be installed 0.5 meter to 1 meter below the ceiling level. Refer to Figure 3.
2. Under flat spare area. If the ceiling height is more than 8 meters, the beam detector should be installed minimum of 0.5 meter below the top ceiling. The maximum height at which the unit should be installed below the ceiling on the air stratification analysis, but is generally up to 4 meters. Refer to Figure 3.
3. The chosen for the location should be clean and dry and not subject to shock, vibration or electro-statistic discharge, and free from glass wall, sunlight direction any reflective barrier.
4. Make sure that the beam path is free form obscuration against moving items.

(The distance between the top of the product and the top of the building is 0.5m - 1 m)

Below 8 meters ceiling height

Above 8 meters ceiling height

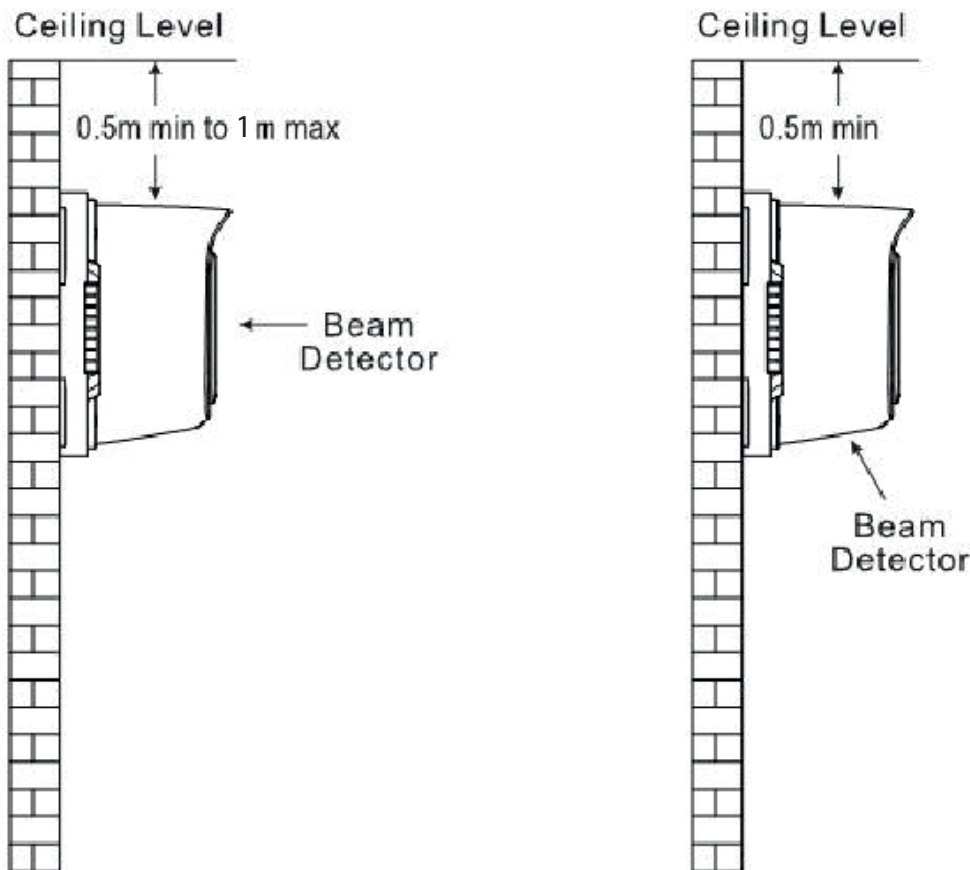
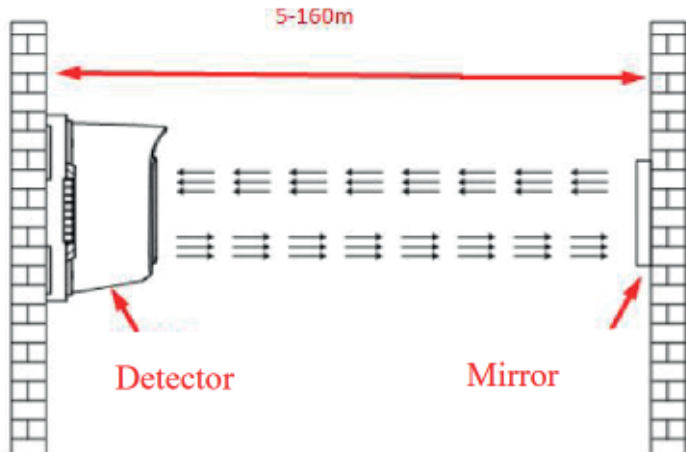

Figure 3: Installation Details

8.2 Detector and mirror installation requirements:

The detector and mirror are required to be installed at the same horizontal position, and the distance between them is 5m -160m



8.3 Mirror Installation Instructions

The mirror is a very important component of this product, which directly affects the signal strength and optical distance. There are some requirements for the detection distance of the detector and the installation number of mirrors :

- 1 If the detection distance is less than 20m, install only one piece.
- 2 If the detection distance is within 20-100 m, install 4 pieces (2* 2).
- 3 The detection distance is above 100m, install 9 pieces(3*3)..Long range extension kit (5 pcs mirrors) should be bought separately.

8.3.1 Mirror specifications

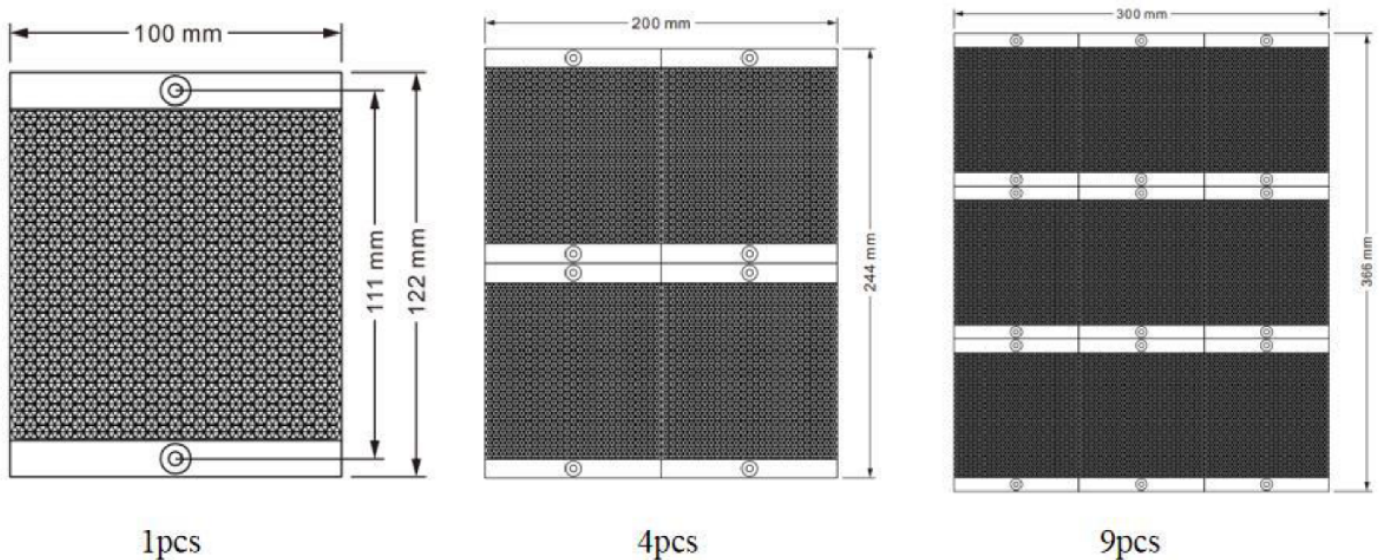

8.4 Install the detector and align of the mirror

During installation, due to some specific environments, there may be some deviations between the installed detector and the mirror, which may cause the optical path signal to be too poor to be used or affect the accuracy of the alarm. We need to adjust the straightness of the detector and the mirror to align the mirror center and parallelism for better and more accurate detection.

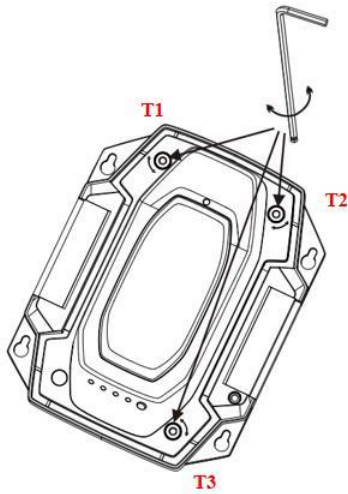

1. First, install the detector on the corresponding surface according to the product installation hole position, tighten the screws, turn on the laser module power, and emit a red laser to align the mirror.
2. Adjust screws T1 , T2 , and T3 according to the position of the laser red dot on the mirror.
3. Adjust the laser point straight up: A Both T1 and T2 should be loosened by similar numbers of turns ; B Only adjust T3, loosen it until it is in the right position; if T1 T3 is not adjusted to the corresponding position, adjust T3 to match it.
4. Adjust the laser point straight down: A Both T1 and T2 should be loosened by similar number of turns; B Only adjust T3 and tighten it until it is in the right position; if T1 T3 is not adjusted to the corresponding position, adjust T3 to match it.
5. Adjust left position: A Both T3 and T2 should be loosened by similar number of turns; B Only adjust T1 and tighten it until it is in the right position; if T2 and T3 are not adjusted to the corresponding position, adjust T1 to match them.
6. Adjust to the right position: A Both T3 and T2 should be adjusted to similar numbers of turns ; B Only adjust T1 , loosen it until it is in the right position; if T2 and T3 are not adjusted to the corresponding position, adjust T1 to match.

9. Working principle and Test Operation

9.1 The detector is placed opposite to the mirror.

The detector consists of two parts: the transmitting part and the receiving part. The transmitting part emits an infrared beam of a certain intensity. After being reflected by the mirror, the receiving part of the detector synchronously collects and amplifies the returned infrared beam, and analyzes and judges the collected signal through the built-in single-chip microcomputer. When smoke enters the detection area, the smoke blocks the light, which reduces the intensity of the infrared light received by the receiving part. When the alarm threshold is reached, the detector lights up the red indicator light and sends out a fire alarm signal.

9.2 Testing Tools

By special test piece;

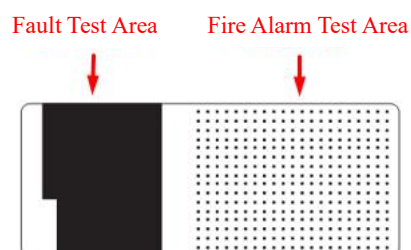

9.3 Fire alarm test method :

Use the fire alarm test area of the test piece to block the detector's transmitting window and receiving window (whole of the detector's filter plate). The detector must report a fire alarm within 20 seconds, and the red LED will light up and lock.

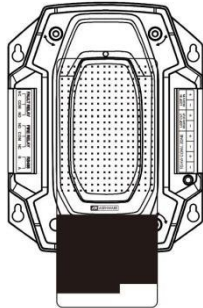

9.4 Fault alarm test:

Use the fault test area of the test piece to block the detector's transmitting window or receiving window (half of the detector's filter plate). The detector must report a fault within 50 seconds, and the yellow LED will light up. It will return to normal after being removed.

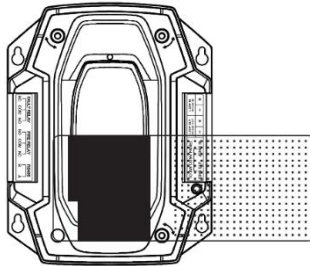

9.5 Switch red laser operation

Under normal conditions, short press the touch switch of ALIGNMENT, press it once to turn on the red laser, and press it again to turn off.

9.6 Calibration

After the detector and mirror are installed according to the standard, they need to be recalibrated. The operation is as following :

A If the calibration is not done for the first time, the yellow LED will flash when the power is on. This means there is no data. Press the ALIGNMENT switch twice within 2 seconds to start automatic calibration, and the green LED flashes quickly.

B If a calibrated product needs to be recalibrated due to changes in the environment or other reasons, you need to press and hold the ALIGNMENT touch switch for more than 3 seconds under normal conditions until the yellow LED flashes, release the ALIGNMENT touch switch, and then quickly press the ALIGNMENT touch switch twice within 2 seconds to start automatic calibration. The green LED flashes quickly.

C When the calibration starts, the red laser will automatically turn on to mark the point, and the red laser will turn off when the calibration is completed or fails.

D When the calibration is successful, the green LED changes from fast flashing to steady on, and the red laser turns off.

E When calibration fails, the green LED goes from flashing quickly to extinguishing, the red laser turns off, and the yellow LED starts flashing again.

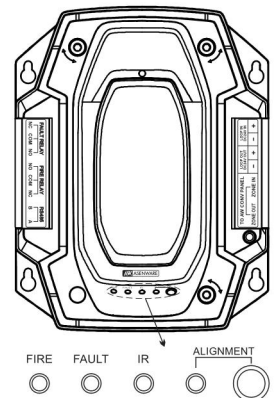

9.7 Addressable Read and Write Address Operations

9.7.1 The 4-pole 2.5 headphone plug cable of the addressable handset is inserted into the headphone burning port or operated wirelessly with the infrared IR adapter.

9.7.2 Press and hold POWER until it starts.

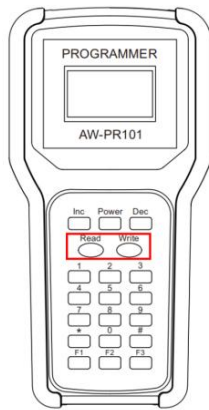
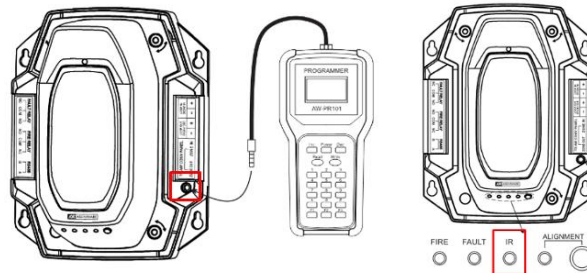

- | | |
|---|----------|
| 1 | Normal |
| 2 | Wireless |
| 3 | T module |
| 4 | 2166-W |

Addr: 001
Success

Addr: 001
Fail

Please press “1” for selecting “1. Normal”.
 Press “Write” for writing address,
 “Success” will be shown when it is done.
 Otherwise “fail” will be shown.
 Press “Read” for reading address,
 “Success” will be shown when it is done.
 Otherwise “fail” will be shown.